

# Medium Weight Caster Series

# HJ Type

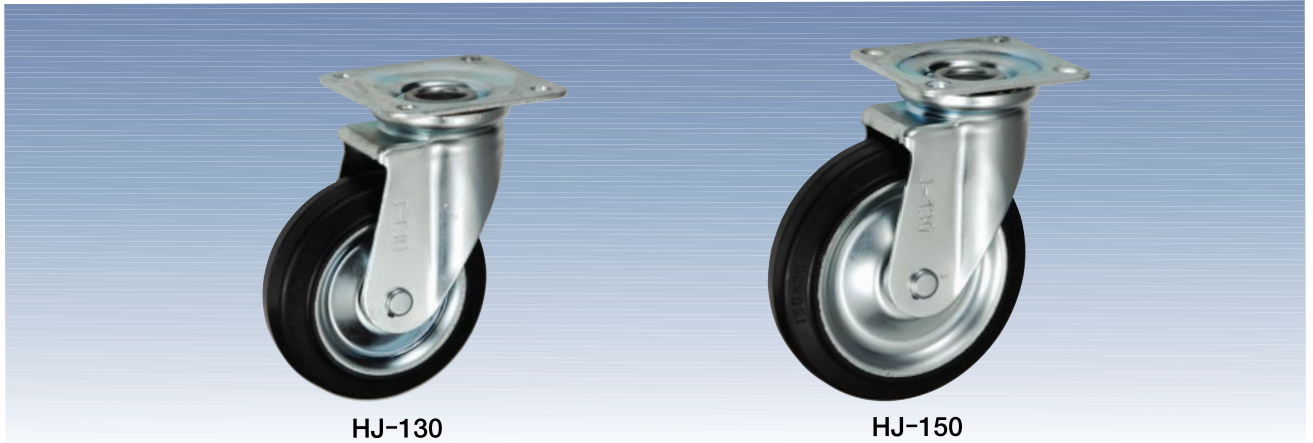







Size: 130mm~150mm

Medium Weight Swivel Caster



HJ-130

HJ-150



Size 	Model Number	Wheel	Bearing	Load Capacity		Tire Width R 	Shaft Diameter D 	Overall Height H1 	Plate Size F1/F2 	Mounting Hole Spacing P1/P2 (P1'/P2') 	Plate Hole d 	Offset E 	Unit: mm
				(daN)	(kgf)								Weight (g)
130	HJ-130	Rubber	B/B	150	153.0	42	12	177	108/108	80/80	11	40	1,540
150	HJ-150	Rubber	B/B	180	183.6	38	12	187	100/100	※80/80 (75/75)	11	40	1,710

Bearing: B/B -- Steel bearing

※Oval-shaped screw holes

### 【Bracket Dimensions】

Unit: mm

Size 	Bracket Height H 	Bracket Width B 
130	112	53
150	112	53

\* The shaft set is included in the bracket.

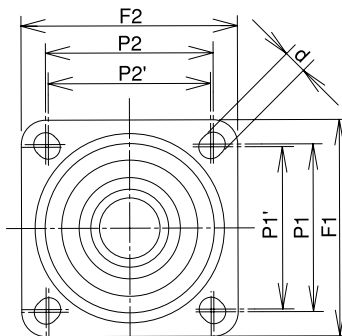

HJ-150

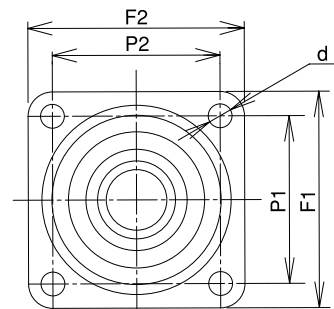

HJ-130

