

JAB_{Type}



Size: 75mm

Stainless Steel Swivel Bracket with Stopper



PJAB-75

PNAJAB-75

Size 	Model Number	Wheel	Bearing	Load Capacity		Tire Width R	Shaft Diameter D	Overall Height H1	Plate Size F1/F2	Mounting Hole Spacing P1/P2	Plate Hole d	Offset E	Weight (g)
				 (daN)	(kgf)								
75	■ Nylon												
	PJAB-75	Nylon		100	102.0	32	10	101	82/82	63/63	9.5	22	470
	PBJAB-75	Nylon	B/B	120	122.4								530
	PBDJAB-75	Nylon	SUS										530
	■ Nylon Rim · Rubber Wheel												
	PNJAB-75	Rubber	B/B	70	71.4	32	10	101	82/82	63/63	9.5	22	560
	PNDJAB-75	Rubber	SUS										560
	PNAJAB-75	Rubber											520
	■ Nylon Rim · Urethane Rubber Wheel												
	PNUJAB-75	Urethane	B/B	100	102.0	32	10	101	82/82	63/63	9.5	22	550
	PNUDJAB-75	Urethane	SUS										550
	PNUAJAB-75	Urethane											70
	■ Monomer Cast Nylon												
	UWBJAB-75	MC Nylon	B/B	150	153.0	24	10	101	82/82	63/63	9.5	22	570
	UWBDJAB-75	MC Nylon	SUS										570
	UWAJAB-75	MC Nylon											530
	UWBSJAB-75	MC Nylon	B/B										550
	UWBSDJAB-75	MC Nylon	SUS										26
	■ Steel Rim · Rubber Wheel Wheel rim is not stainless steel.												
	SJAB-75	Rubber	B/B	80	81.6	32	10	101	82/82	63/63	9.5	22	580
	SRJAB-75	Red Rubber	B/B	60	61.2								580
CRJAB-75	Heat-resistance	B/B	80	81.6	600								
■ Steel Rim · Urethane Rubber Wheel Wheel rim is not stainless steel.													
SUIJAB-75	Urethane	B/B	120	122.4	32	10	101	82/82	63/63	9.5	22	660	
SUIEJAB-75	Anti-Static	B/B										660	

Unit: mm

● The stopper pedal for left foot is not available.

Bearing: No mark -- Spindle sleeve, B/B -- Steel bearing, SUS -- Stainless steel bearing

Build-to-order manufacturing

The JAB Type bracket can lock or unlock the wheel and frame at the same time just by stepping the pedal.

● The materials of JAB Type bracket are all stainless steel (SUS 304 / 18-8 stainless), except plate springs.

For plate springs, SK5 (carbon tool steel) is used for maintaining spring performance, and the surface is plated with nickel chrome.

JAB_{Type}

Size: 100mm

Stainless Steel Swivel Bracket with Stopper



PJAB-100



PNAJAB-100

Stainless Steel Caster Series

Unit: mm

Size 	Model Number	Wheel	Bearing	Load Capacity		Tire Width R	Shaft Diameter D	Overall Height H1	Plate Size F1/F2	Mounting Hole Spacing P1/P2	Plate Hole d	Offset E	Weight (g)	
				(daN)	(kgf)									
100	■ Nylon													
	PJAB-100	Nylon		120	122.4									990
	PBJAB-100	Nylon	B/B	180	183.6	35	12	144	95/95	71/71	11	35	1,050	
	PBDJAB-100	Nylon	SUS										1,050	
	■ Nylon Rim · Rubber Wheel													
	PNJAB-100	Rubber	B/B											1,090
	PNDJAB-100	Rubber	SUS	100	102.0	32	12	144	95/95	71/71	11	35	1,090	
	PNAJAB-100	Rubber												1,030
	■ Nylon Rim · Urethane Rubber Wheel													
	PNUJAB-100	Urethane	B/B	150	153.0	32	12	144	95/95	71/71	11	35	1,070	
	PNUDJAB-100	Urethane	SUS											1,070
	PNUAJAB-100	Urethane		100	102.0									1,010
	■ Monomer Cast Nylon													
	UWBJAB-100	MC Nylon	B/B											1,200
	UWBDJAB-100	MC Nylon	SUS			29								1,200
	UWAJAB-100	MC Nylon		200	204.0		12	144	95/95	71/71	11	35	1,150	
	UWBSJAB-100	MC Nylon	B/B			30								1,150
	UWBSDJAB-100	MC Nylon	SUS											1,150
	■ Steel Rim · Rubber Wheel Wheel rim is not stainless steel.													
	SJAB-100	Rubber	B/B	130	132.6									1,190
SRJAB-100	Red Rubber	B/B	100	102.0	35	12	144	95/95	71/71	11	35	1,190		
CRJAB-100	Heat-resistance	B/B	130	132.6									1,220	
■ Steel Rim · Urethane Rubber Wheel Wheel rim is not stainless steel.														
SUIJAB-100	Urethane	B/B											1,260	
SUIEJAB-100	Anti-Static	B/B	180	183.6	32	12	144	95/95	71/71	11	35	1,260		

● The stopper pedal for left foot is not available.

Bearing: No mark -- Spindle sleeve, B/B -- Steel bearing, SUS -- Stainless steel bearing

 Build-to-order manufacturing

The JAB Type bracket can lock or unlock the wheel and frame at the same time just by stepping the pedal.

● The materials of JAB Type bracket are all stainless steel (SUS 304 / 18-8 stainless), except plate springs.

For plate springs, SK5 (carbon tool steel) is used for maintaining spring performance, and the surface is plated with nickel chrome.







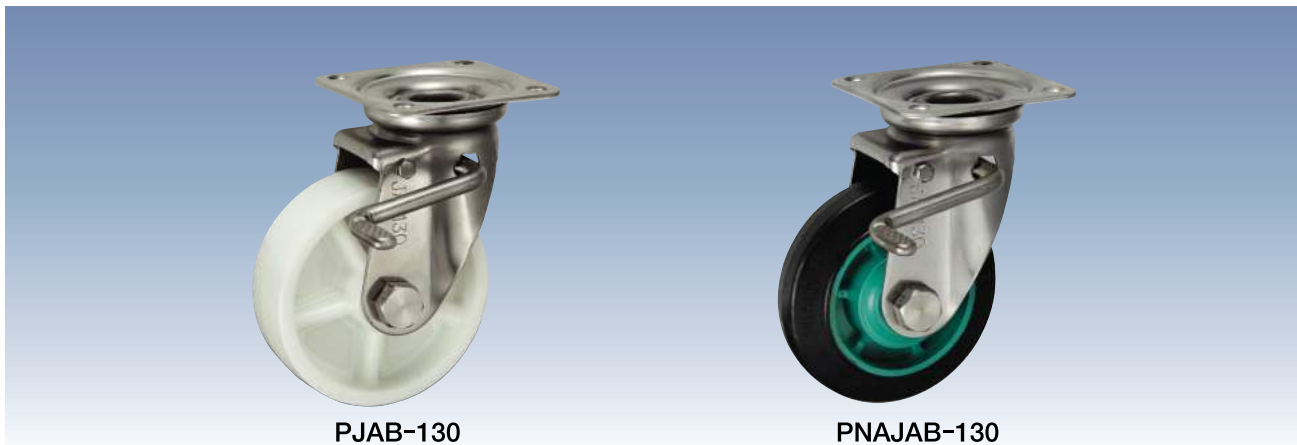

JAB_{Type}

Size: 130mm

Stainless Steel Swivel Bracket with Stopper



Unit: mm

Size 	Model Number	Wheel	Bearing	Load Capacity		Tire Width R 	Shaft Diameter D 	Overall Height H1 	Plate Size F1/F2 	Mounting Hole Spacing P1/P2 	Plate Hole d 	Offset E 	Weight (g) 
				(daN)	(kgf)								
130	■ Nylon												
	PJAB-130	Nylon		150	153.0	42	20	177	108/108	80/80	11	40	1,580
	PBJAB-130	Nylon	B/B	250	255.0								1,780
	PBDJAB-130	Nylon	SUS										1,780
	■ Nylon Rim · Rubber Wheel												
	PNJAB-130	Rubber	B/B	145	147.9	38	20	177	108/108	80/80	11	40	1,840
	PNDJAB-130	Rubber	SUS										1,840
	PNAJAB-130	Rubber											120
	■ Nylon Rim · Urethane Rubber Wheel												
	PNUJAB-130	Urethane	B/B	200	204.0	35	20	177	108/108	80/80	11	40	1,780
	PNUDJAB-130	Urethane	SUS										1,780
	PNUAJAB-130	Urethane											120
	■ Monomer Cast Nylon												
	UWBJAB-130	MC Nylon	B/B	300	306.0	36	20	177	108/108	80/80	11	40	2,060
	UWBDJAB-130	MC Nylon	SUS										2,060
	UWAJAB-130	MC Nylon											1,910
	UWBSJAB-130	MC Nylon	B/B			30							1,800
	UWBSDJAB-130	MC Nylon	SUS										1,800
	■ Steel Rim · Rubber Wheel Wheel rim is not stainless steel.												
	SJAB-130	Rubber	B/B	180	183.6	42	20	177	108/108	80/80	11	40	2,040
SRJAB-130	Red Rubber	B/B	140	142.8	2,040								
CRJAB-130	Heat-resistance	B/B	180	183.6	2,070								
■ Steel Rim · Urethane Rubber Wheel Wheel rim is not stainless steel.													
SUIJAB-130	Urethane	B/B	250	255.0	35	20	177	108/108	80/80	11	40	2,170	
SUIEJAB-130	Anti-Static	B/B										2,170	

●The stopper pedal for left foot is not available.

Bearing: No mark -- Spindle sleeve, B/B -- Steel bearing, SUS -- Stainless steel bearing

Build-to-order manufacturing

The JAB Type bracket can lock or unlock the wheel and frame at the same time just by stepping the pedal.

●The materials of JAB Type bracket are all stainless steel (SUS 304 / 18-8 stainless), except plate springs.

For plate springs, SK5 (carbon tool steel) is used for maintaining spring performance, and the surface is plated with nickel chrome.

JAB_{Type}

Size: 150mm

Stainless Steel Swivel Bracket with Stopper



PJOB-150



PNAJAB-150

Stainless Steel Caster Series

Unit: mm

Size 	Model Number	Wheel	Bearing	Load Capacity		Tire Width R	Shaft Diameter D	Overall Height H1	Plate Size F1/F2	Mounting Hole Spacing P1/P2	Plate Hole d	Offset E	Weight (g)	
				(daN)	(kgf)									
150	■ Nylon													
	PJOB-150	Nylon		180	183.6									2,080
	PBJAB-150	Nylon	B/B	300	306.0	45	20	198	120/120	90/90	11	45	2,320	
	PBDJAB-150	Nylon	SUS										2,320	
	■ Nylon Rim · Rubber Wheel													
	PNJAB-150	Rubber	B/B											2,340
	PNDJAB-150	Rubber	SUS	175	178.5	38	20	198	120/120	90/90	11	45	2,340	
	PNAJAB-150	Rubber		140	142.8									2,180
	■ Nylon Rim · Urethane Rubber Wheel													
	PNUJAB-150	Urethane	B/B											2,300
	PNUDJAB-150	Urethane	SUS	250	255.0	38	20	198	120/120	90/90	11	45	2,300	
	PNUAJAB-150	Urethane		150	153.0									2,110
	■ Monomer Cast Nylon													
	UWBJAB-150	MC Nylon	B/B											2,760
	UWBDJAB-150	MC Nylon	SUS			40								2,760
	UWAJAB-150	MC Nylon		350	357.0		20	198	120/120	90/90	11	45	2,610	
	UWBSJAB-150	MC Nylon	B/B			30								2,360
	UWBSDJAB-150	MC Nylon	SUS											2,360
	■ Steel Rim · Rubber Wheel Wheel rim is not stainless steel.													
	SJAB-150	Rubber	B/B	200	204.0									2,630
SRJAB-150	Red Rubber	B/B	160	163.2	45	20	198	120/120	90/90	11	45	2,630		
CRJAB-150	Heat-resistance	B/B	200	204.0									2,670	
■ Steel Rim · Urethane Rubber Wheel Wheel rim is not stainless steel.														
SUIJAB-150	Urethane	B/B											2,820	
SUIEJAB-150	Anti-Static	B/B	300	306.0	38	20	198	120/120	90/90	11	45	2,820		

● The stopper pedal for left foot is not available.

Bearing: No mark -- Spindle sleeve, B/B -- Steel bearing, SUS -- Stainless steel bearing

 Build-to-order manufacturing

The JAB Type bracket can lock or unlock the wheel and frame at the same time just by stepping the pedal.

● The materials of JAB Type bracket are all stainless steel (SUS 304 / 18-8 stainless), except plate springs.

For plate springs, SK5 (carbon tool steel) is used for maintaining spring performance, and the surface is plated with nickel chrome.

JAB_{Type}

Size: 200mm

Stainless Steel Swivel Bracket with Stopper

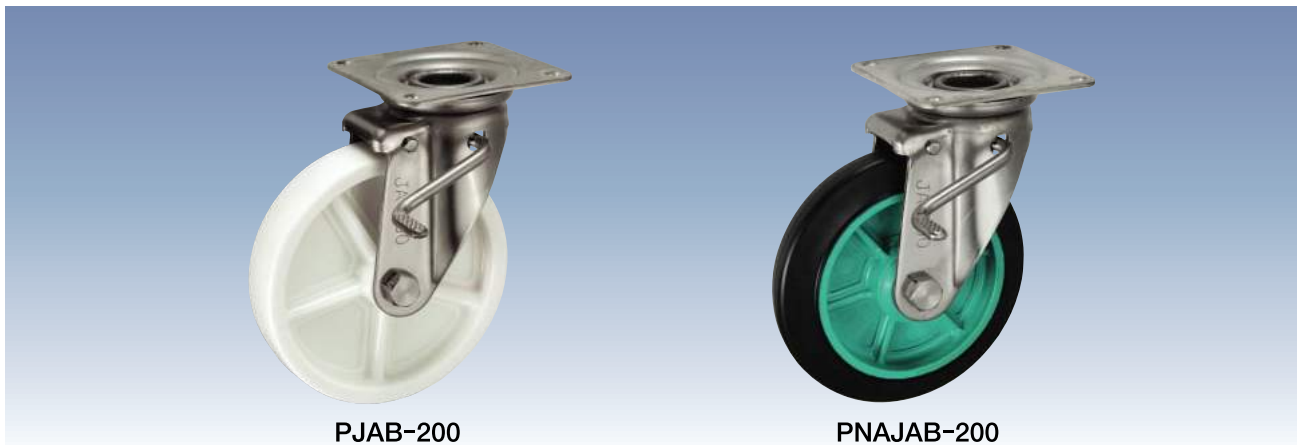

PJAB-200

PNAJAB-200

Size 	Model Number	Wheel	Bearing	Load Capacity		Tire Width R	Shaft Diameter D	Overall Height H1	Plate Size F1/F2	Mounting Hole Spacing P1/P2	Plate Hole d	Offset E	Weight (g)	
				(daN)	(kgf)									
200	■ Nylon													
	PJAB-200	Nylon		250	255.0	45	20	250	140/140	112/112	11	58	3,120	
	PBJAB-200	Nylon	B/B	400	408.0								3,330	
	PBDJAB-200	Nylon	SUS										3,330	
	■ Nylon Rim · Rubber Wheel													
	PNJAB-200	Rubber	B/B	220	224.4	42	20	250	140/140	112/112	11	58	3,400	
	PNDJAB-200	Rubber	SUS										3,400	
	PNAJAB-200	Rubber											160	163.2
	■ Nylon Rim · Urethane Rubber Wheel													
	PNUJAB-200	Urethane	B/B	350	357.0	42	20	250	140/140	112/112	11	58	3,270	
	PNUDJAB-200	Urethane	SUS										3,270	
	PNUAJAB-200	Urethane											250	255.0
	■ Monomer Cast Nylon													
	UWBJAB-200	MC Nylon	B/B	500	510.0	42	20	250	140/140	112/112	11	58	4,280	
	UWBDJAB-200	MC Nylon	SUS										4,280	
	UWAJAB-200	MC Nylon											4,130	
	UWBSJAB-200	MC Nylon	B/B										3,740	
	UWBSDJAB-200	MC Nylon	SUS			34	3,740							
	■ Steel Rim · Rubber Wheel Wheel rim is not stainless steel.													
	SJAB-200	Rubber	B/B	250	255.0	45	20	250	140/140	112/112	11	58	4,050	
	SRJAB-200	Red Rubber	B/B	200	204.0								4,050	
	SHJAB-200	High-Rebound	B/B	250	255.0								4,050	
	CRJAB-200	Heat-resistance	B/B										4,130	
■ Steel Rim · Urethane Rubber Wheel Wheel rim is not stainless steel.														
SUIJAB-200	Urethane	B/B	400	408.0	42	20	250	140/140	112/112	11	58	4,220		
SUIEJAB-200	Anti-Static	B/B										4,220		

Unit: mm

●The stopper pedal for left foot is not available.

Bearing: No mark -- Spindle sleeve, B/B -- Steel bearing, SUS -- Stainless steel bearing

Build-to-order manufacturing

The JAB Type bracket can lock or unlock the wheel and frame at the same time just by stepping the pedal.

●The materials of JAB Type bracket are all stainless steel (SUS 304 / 18-8 stainless), except plate springs.

For plate springs, SK5 (carbon tool steel) is used for maintaining spring performance, and the surface is plated with nickel chrome.

JAB_{Type}



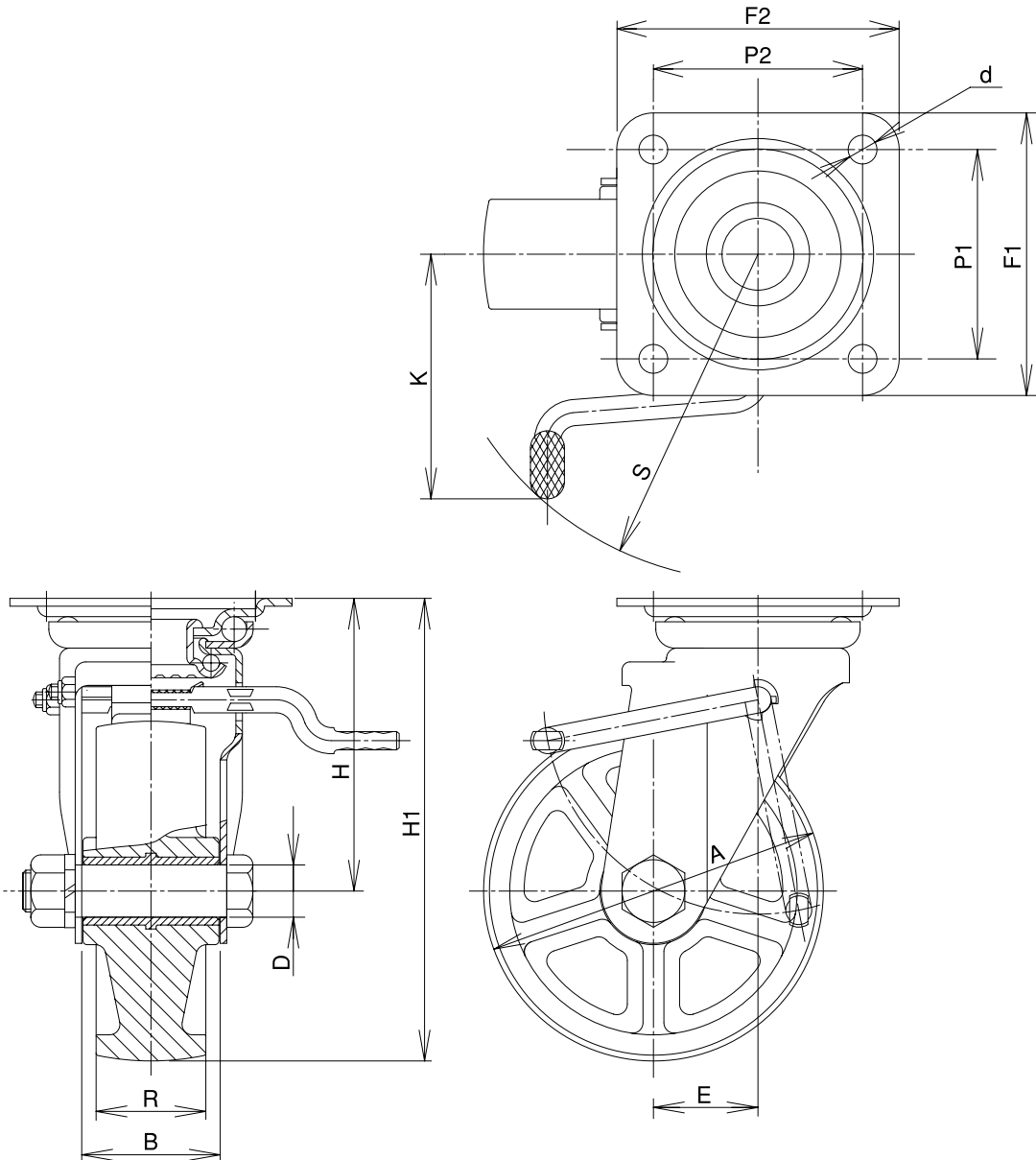

Stainless Steel Swivel Bracket with Stopper

Stainless Steel Caster Series





[Bracket Dimensions]

Unit: mm

Size 	Load Capacity		Bracket Height H 	Bracket Width B 	Weight (g) 
	(daN)	(kgf)			
75	150	153.0	63	40	380
100	200	204.0	94	43	830
130	300	306.0	112	53	1,260
150	350	357.0	123	56	1,670
200	500	510.0	150	56	2,380

[Pedal Dimensions]

Unit: mm

Size 	Pedal Rod K 	Radius of Gyration S 
75	65	82
100	92	112
130	105	135
150	108	140
200	120	148

Notice

The materials of JAB Type bracket are all stainless steel, but the following wheels are not stainless steel. In addition, stainless steel bearings cannot be set.
Please be careful when selecting a caster.

Steel Rim·Rubber Wheel (S, SR, SH, CR Type)
Steel Rim·Urethane Wheel (SUI, SUIE Type)

* The shaft set is included in the bracket.