

# Medium Weight Caster Series

## J Type

Size: 75mm

Medium Weight Swivel Bracket

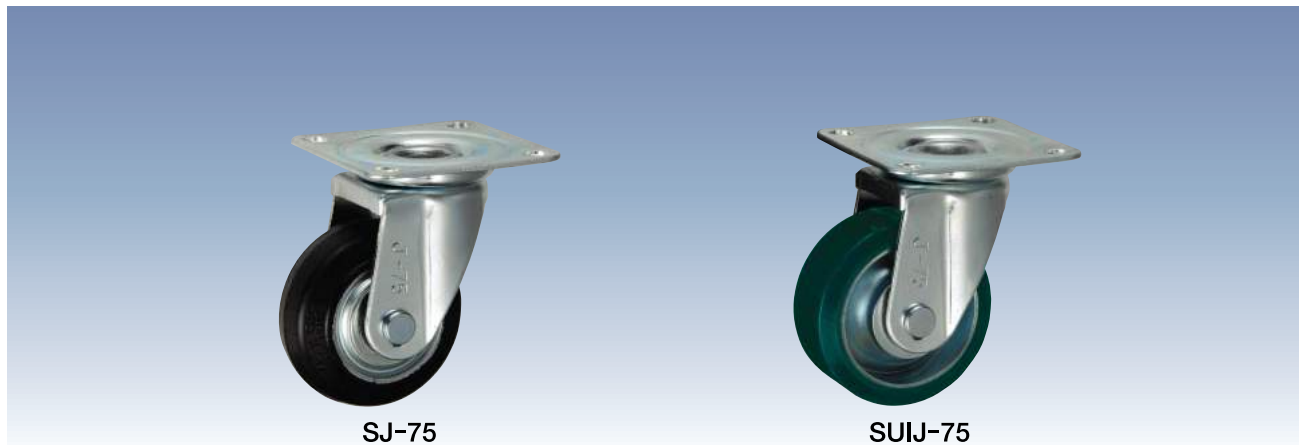

Unit: mm

Size 	Model Number	Wheel	Bearing	Load Capacity		Tire Width R 	Shaft Diameter D 	Overall Height H1 	Plate Size F1/F2 	Mounting Hole Spacing P1/P2 	Plate Hole d 	Offset E 	Weight (g) 
				(daN)	(kgf)								
75	■ Steel Rim · Rubber Wheel												
	SJ-75	Rubber	B/B	80	81.6	32	10	101	82/82	63/63	9.5	22	570
	SRJ-75	Red Rubber	B/B	60	61.2								570
	CRJ-75	Heat-resistance	B/B	80	81.6								590
	■ Steel Rim · Urethane Rubber Wheel												
	SUIJ-75	Urethane	B/B	120	122.4	32	10	101	82/82	63/63	9.5	22	650
	SUIEJ-75	Anti-Static	B/B										650
	■ Nylon Rim · Rubber Wheel												
	PNJ-75	Rubber	B/B	70	71.4	32	10	101	82/82	63/63	9.5	22	550
	PNDJ-75	Rubber	SUS										550
	PNAJ-75	Rubber											510
	■ Nylon Rim · Urethane Rubber Wheel												
	PNUJ-75	Urethane	B/B	100	102.0	32	10	101	82/82	63/63	9.5	22	540
	PNUDJ-75	Urethane	SUS										540
	PNUAJ-75	Urethane		70	71.4								490
	■ Nylon												
	PJ-75	Nylon		100	102.0	32	10	101	82/82	63/63	9.5	22	460
	PBJ-75	Nylon	B/B	120	122.4								520
	PBDJ-75	Nylon	SUS										520
	■ Monomer Cast Nylon												
	UWBJ-75	MC Nylon	B/B	120	122.4	24	10	101	82/82	63/63	9.5	22	560
UWBDJ-75	MC Nylon	SUS	560										
UWAJ-75	MC Nylon		520										
UWBSJ-75	MC Nylon	B/B	540										
UWBSDJ-75	MC Nylon	SUS	26			540							

Bearing: No mark -- Spindle sleeve, B/B -- Steel bearing, SUS -- Stainless steel bearing

Build-to-order manufacturing

# J Type

Size: 100mm

## Medium Weight Swivel Bracket

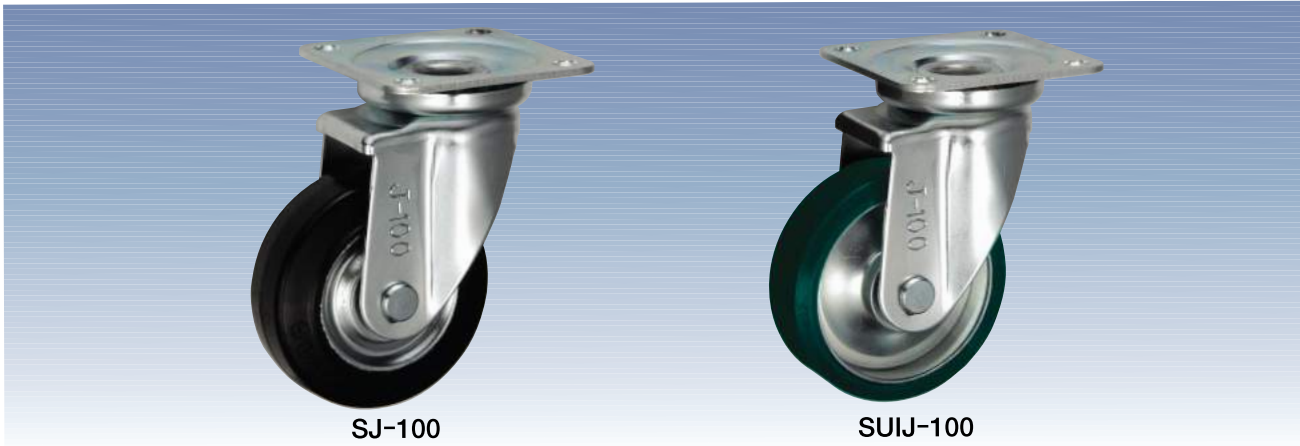

Medium Weight Caster Series

Size 	Model Number	Wheel	Bearing	Load Capacity		Tire Width R	Shaft Diameter D	Overall Height H1	Plate Size F1/F2	Mounting Hole Spacing P1/P2	Plate Hole d	Offset E	Weight (g)	
				(daN)	(kgf)									
100	<b>■ Steel Rim · Rubber Wheel</b>													
	SJ-100	Rubber	B/B	130	132.6	35	12	144	95/95	71/71	11	35	1,100	
	SRJ-100	Red Rubber	B/B	100	102.0								1,100	
	CRJ-100	Heat-resistance	B/B	130	132.6								1,130	
	<b>■ Steel Rim · Urethane Rubber Wheel</b>													
	SUIJ-100	Urethane	B/B	180	183.6	32	12	144	95/95	71/71	11	35	1,170	
	SUIEJ-100	Anti-Static	B/B										1,170	
	<b>■ Nylon Rim · Rubber Wheel</b>													
	PNJ-100	Rubber	B/B	100	102.0	32	12	144	95/95	71/71	11	35	1,000	
	PNDJ-100	Rubber	SUS										1,000	
	PNAJ-100	Rubber											940	
	<b>■ Nylon Rim · Urethane Rubber Wheel</b>													
	PNUJ-100	Urethane	B/B	150	153.0	32	12	144	95/95	71/71	11	35	980	
	PNUDJ-100	Urethane	SUS										980	
	PNUAJ-100	Urethane		100	102.0								920	
	<b>■ Nylon</b>													
	PJ-100	Nylon		120	122.4	35	12	144	95/95	71/71	11	35	900	
	PBJ-100	Nylon	B/B	180	183.6								960	
	PBDJ-100	Nylon	SUS	180	183.6								960	
	<b>■ Monomer Cast Nylon</b>													
UWBJ-100	MC Nylon	B/B	180	183.6	29	12	144	95/95	71/71	11	35	1,110		
UWBDJ-100	MC Nylon	SUS										1,110		
UWAJ-100	MC Nylon											1,060		
UWBSJ-100	MC Nylon	B/B			30							1,060		
UWBSDJ-100	MC Nylon	SUS										1,060		

Bearing: No mark -- Spindle sleeve, B/B -- Steel bearing, SUS -- Stainless steel bearing

Build-to-order manufacturing

# Medium Weight Caster Series

## J Type





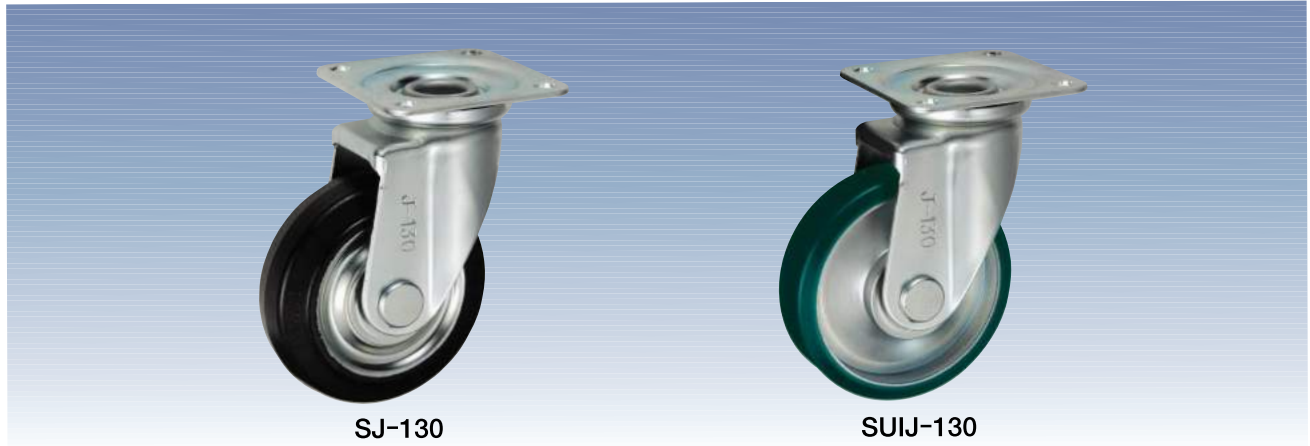



Size: 130mm

Medium Weight Swivel Bracket



SJ-130

SUIJ-130

Size 	Model Number	Wheel	Bearing	Load Capacity		Tire Width R 	Shaft Diameter D 	Overall Height H1 	Plate Size F1/F2 	Mounting Hole Spacing P1/P2 	Plate Hole d 	Offset E 	Weight (g) 
				(daN)	(kgf)								
130	■ Steel Rim · Rubber Wheel												
	SJ-130	Rubber	B/B	180	183.6	42	20	177	108/108	80/80	11	40	1,870
	SRJ-130	Red Rubber	B/B	140	142.8								1,870
	CRJ-130	Heat-resistance	B/B	180	183.6								1,900
	■ Steel Rim · Urethane Rubber Wheel												
	SUIJ-130	Urethane	B/B	250	255.0	35	20	177	108/108	80/80	11	40	2,000
	SUIEJ-130	Anti-Static	B/B										2,000
	■ Nylon Rim · Rubber Wheel												
	PNJ-130	Rubber	B/B	145	147.9	38	20	177	108/108	80/80	11	40	1,670
	PNDJ-130	Rubber	SUS										1,670
	PNAJ-130	Rubber		120	122.4								1,480
	■ Nylon Rim · Urethane Rubber Wheel												
	PNUJ-130	Urethane	B/B	200	204.0	35	20	177	108/108	80/80	11	40	1,610
	PNUDJ-130	Urethane	SUS										1,610
	PNUAJ-130	Urethane		120	122.4								1,420
	■ Nylon												
	PJ-130	Nylon		150	153.0	42	20	177	108/108	80/80	11	40	1,410
	PBJ-130	Nylon	B/B	250	255.0								1,610
	PBDJ-130	Nylon	SUS										1,610
	■ Monomer Cast Nylon												
UWBJ-130	MC Nylon	B/B	250	255.0	36	20	177	108/108	80/80	11	40	1,890	
UWB DJ-130	MC Nylon	SUS										1,890	
UWAJ-130	MC Nylon											1,740	
UWBSJ-130	MC Nylon	B/B			30							1,630	
UWBSDJ-130	MC Nylon	SUS										1,630	

Unit: mm

Bearing: No mark -- Spindle sleeve, B/B -- Steel bearing, SUS -- Stainless steel bearing

 Build-to-order manufacturing

# J Type

Size: 150mm

## Medium Weight Swivel Bracket



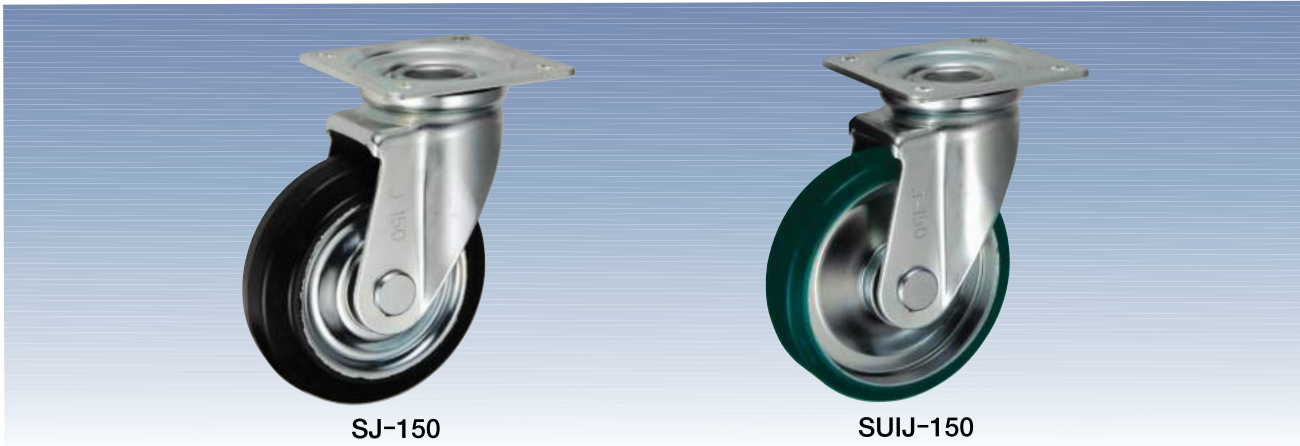





Medium Weight Caster Series



SJ-150

SUIJ-150

Unit: mm

Size 	Model Number	Wheel	Bearing	Load Capacity		Tire Width R 	Shaft Diameter D 	Overall Height H1 	Plate Size F1/F2 	Mounting Hole Spacing P1/P2 	Plate Hole d 	Offset E 	Weight (g) 	
				(daN)	(kgf)									
150	<b>■ Steel Rim · Rubber Wheel</b>													
	SJ-150	Rubber	B/B	200	204.0	45	20	198	120/120	90/90	11	45	2,510	
	SRJ-150	Red Rubber	B/B	160	163.2								2,510	
	CRJ-150	Heat-resistance	B/B	200	204.0								2,550	
	<b>■ Steel Rim · Urethane Rubber Wheel</b>													
	SUIJ-150	Urethane	B/B	300	306.0	38	20	198	120/120	90/90	11	45	2,700	
	SUIEJ-150	Anti-Static	B/B	300	306.0								2,700	
	<b>■ Nylon Rim · Rubber Wheel</b>													
	PNJ-150	Rubber	B/B	175	178.5	38	20	198	120/120	90/90	11	45	2,220	
	PNDJ-150	Rubber	SUS										2,220	
	PNAJ-150	Rubber											140	142.8
	<b>■ Nylon Rim · Urethane Rubber Wheel</b>													
	PNUJ-150	Urethane	B/B	250	255.0	38	20	198	120/120	90/90	11	45	2,180	
	PNUDJ-150	Urethane	SUS										2,180	
	PNUAJ-150	Urethane											150	153.0
	<b>■ Nylon</b>													
	PJ-150	Nylon		180	183.6	45	20	198	120/120	90/90	11	45	1,960	
	PBJ-150	Nylon	B/B	300	306.0								2,200	
	PBDJ-150	Nylon	SUS	300	306.0								2,200	
	<b>■ Monomer Cast Nylon</b>													
UWBJ-150	MC Nylon	B/B	300	306.0	40	20	198	120/120	90/90	11	45	2,640		
UWBDJ-150	MC Nylon	SUS										2,640		
UWAJ-150	MC Nylon											2,490		
UWBSJ-150	MC Nylon	B/B										2,240		
UWBSDJ-150	MC Nylon	SUS			30							2,240		

Bearing: No mark -- Spindle sleeve, B/B -- Steel bearing, SUS -- Stainless steel bearing

Build-to-order manufacturing

# Medium Weight Caster Series

## J Type





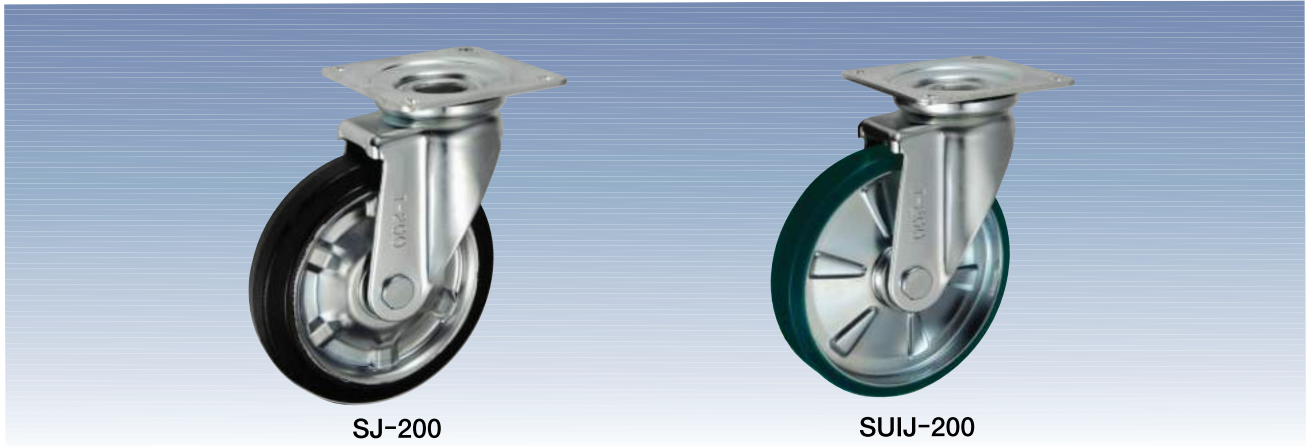



Size: 200mm

Medium Weight Swivel Bracket



SJ-200

SUIJ-200

Size 	Model Number	Wheel	Bearing	Load Capacity		Tire Width R 	Shaft Diameter D 	Overall Height H1 	Plate Size F1/F2 	Mounting Hole Spacing P1/P2 	Plate Hole d 	Offset E 	Weight (g) 
				(daN)	(kgf)								
200	■ Steel Rim · Rubber Wheel												
	SJ-200	Rubber	B/B	250	255.0	45	20	250	140/140	112/112	11	58	4,030
	SRJ-200	Red Rubber	B/B	200	204.0								4,030
	SHJ-200	High-Rebound	B/B	250	255.0								4,030
	CRJ-200	Heat-resistance	B/B										4,110
	■ Steel Rim · Urethane Rubber Wheel												
	SUIJ-200	Urethane	B/B	400	408.0	42	20	250	140/140	112/112	11	58	4,200
	SUIEJ-200	Anti-Static	B/B										4,200
	■ Nylon Rim · Rubber Wheel												
	PNJ-200	Rubber	B/B	220	224.4	42	20	250	140/140	112/112	11	58	3,380
	PNDJ-200	Rubber	SUS										3,380
	PNAJ-200	Rubber											160
	■ Nylon Rim · Urethane Rubber Wheel												
	PNUJ-200	Urethane	B/B	350	357.0	42	20	250	140/140	112/112	11	58	3,250
	PNUDJ-200	Urethane	SUS										3,250
	PNUAJ-200	Urethane											250
	■ Nylon												
	PJ-200	Nylon		250	255.0	45	20	250	140/140	112/112	11	58	3,100
	PBJ-200	Nylon	B/B	400	408.0								3,310
	PBDJ-200	Nylon	SUS										3,310
	■ Monomer Cast Nylon												
	UWBJ-200	MC Nylon	B/B	420	428.4	42	20	250	140/140	112/112	11	58	4,260
UWBDJ-200	MC Nylon	SUS	4,260										
UWAJ-200	MC Nylon		4,110										
UWBSJ-200	MC Nylon	B/B	34			3,720							
UWBSDJ-200	MC Nylon	SUS				3,720							

Unit: mm

Bearing: No mark -- Spindle sleeve, B/B -- Steel bearing, SUS -- Stainless steel bearing

 Build-to-order manufacturing

# J Type

Size: 250mm~300mm

## Medium Weight Swivel Bracket

Medium Weight Caster Series



SJ-250

SUIJ-250

Unit: mm

Size 	Model Number	Wheel	Bearing	Load Capacity		Tire Width R	Shaft Diameter D	Overall Height H1	Plate Size F1/F2	Mounting Hole Spacing P1/P2	Plate Hole d	Offset E	Weight (g)
				(daN)	(kgf)								
250	■ Steel Rim · Rubber Wheel												
	SJ-250	Rubber	B/B	330	336.6	50	25	305	160/160	125/125	14	71	6,080
	SRJ-250	Red Rubber	B/B	260	265.2								6,080
	CRJ-250	Heat-resistance	B/B	330	336.6								6,300
	■ Steel Rim · Urethane Rubber Wheel												
SUIJ-250	Urethane	B/B	500	510.0	45	25	305	160/160	125/125	14	71	6,640	
300	■ Monomer Cast Nylon												
	UWBSJ-250	MC Nylon	B/B	550	561.0	36	25	305	160/160	125/125	14	71	5,800
	■ Steel Rim · Rubber Wheel												
	SJ-300	Rubber	B/B	350	357.0	50	25	374	175/175	140/140	14	71	9,290
■ Steel Rim · Urethane Rubber Wheel													
SUIJ-300	Urethane	B/B	600	612.0	50	25	374	175/175	140/140	14	71	8,960	

Bearing: B/B -- Steel bearing

Build-to-order manufacturing

### [Bracket Dimensions]

Unit: mm

Size 	Load Capacity		Bracket Height H	Bracket Width B	Weight (g)
	(daN)	(kgf)			
75	120	122.4	63	40	370
100	180	183.6	94	43	740
130	250	255.0	112	53	1,090
150	300	306.0	123	56	1,550
200	420	428.4	150	56	2,360
250	550	561.0	180	90	3,560
300	600	612.0	224	110	4,520

\* The shaft set is included in the bracket.

