

# KABZ<sub>Type</sub>

Size: 75mm

Stainless Steel Rigid Bracket with Stopper

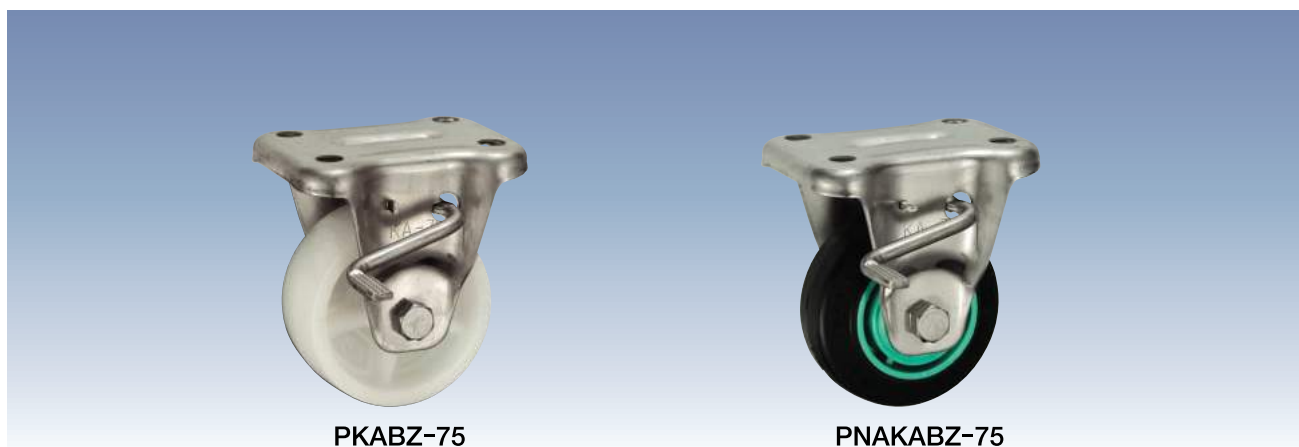

PKABZ-75

PNAKABZ-75

Size 	Model Number	Wheel	Bearing	Load Capacity		Tire Width R	Shaft Diameter D	Overall Height H1	Plate Size F1/F2	Mounting Hole Spacing P1/P2	Plate Hole d	Weight (g)	
				(daN)	(kgf)								
75	<b>■ Nylon</b>												
	PKABZ-75	Nylon		100	102.0	32	10	101	91/68	63/40	9.5	360	
	PBKABZ-75	Nylon	B/B	120	122.4							420	
	PBDKABZ-75	Nylon	SUS									420	
	<b>■ Nylon Rim · Rubber Wheel</b>												
	PNKABZ-75	Rubber	B/B	70	71.4	32	10	101	91/68	63/40	9.5	450	
	PNDKABZ-75	Rubber	SUS									450	
	PNAKABZ-75	Rubber										410	
	<b>■ Nylon Rim · Urethane Rubber Wheel</b>												
	PNUKABZ-75	Urethane	B/B	100	102.0	32	10	101	91/68	63/40	9.5	440	
	PNUDKABZ-75	Urethane	SUS									440	
	PNUAKABZ-75	Urethane										390	
	<b>■ Monomer Cast Nylon</b>												
	UWBKABZ-75	MC Nylon	B/B	150	153.0	24	10	101	91/68	63/40	9.5	460	
	UWBDKABZ-75	MC Nylon	SUS									460	
	UWAKABZ-75	MC Nylon										420	
	UWBSKABZ-75	MC Nylon	B/B									440	
	UWBSDKABZ-75	MC Nylon	SUS			26	440						
	<b>■ Steel Rim · Rubber Wheel</b> <i>Wheel rim is not stainless steel.</i>												
	SKABZ-75	Rubber	B/B	80	81.6	32	10	101	91/68	63/40	9.5	470	
	SRKABZ-75	Red Rubber	B/B	60	61.2							470	
CRKABZ-75	Heat-resistance	B/B	80	81.6	490								
<b>■ Steel Rim · Urethane Rubber Wheel</b> <i>Wheel rim is not stainless steel.</i>													
SUIKABZ-75	Urethane	B/B	120	122.4	32	10	101	91/68	63/40	9.5	550		
SUIEKABZ-75	Anti-Static	B/B									550		

Unit: mm

● The stopper pedal for left foot is available (KABZ-75 → KABZL-75).

Bearing: No mark -- Spindle sleeve, B/B -- Steel bearing, SUS -- Stainless steel bearing

     Build-to-order manufacturing

The stopper of the KABZ Type bracket can lock the wheel to stop the caster.

● The materials of KABZ Type bracket are all stainless steel (SUS 304 / 18-8 stainless), except plate springs.

For plate springs, SK5 (carbon tool steel) is used for maintaining spring performance, and the surface is plated with nickel chrome.

# KABZ Type

Size: 100mm

Stainless Steel Rigid Bracket with Stopper



PKABZ-100



PNAKABZ-100

Unit: mm

Size 	Model Number	Wheel	Bearing	Load Capacity		Tire Width R	Shaft Diameter D	Overall Height H1	Plate Size F1/F2	Mounting Hole Spacing P1/P2	Plate Hole d	Weight (g)	
				(daN)	(kgf)								
100	■ Nylon												
	PKABZ-100	Nylon		120	122.4	35	12	144	115/80	80/45	11	690	
	PBKABZ-100	Nylon	B/B	180	183.6							750	
	PBDKABZ-100	Nylon	SUS									750	
	■ Nylon Rim · Rubber Wheel												
	PNKABZ-100	Rubber	B/B	100	102.0	32	12	144	115/80	80/45	11	790	
	PNDKABZ-100	Rubber	SUS									790	
	PNAKABZ-100	Rubber										730	
	■ Nylon Rim · Urethane Rubber Wheel												
	PNUKABZ-100	Urethane	B/B	150	153.0	32	12	144	115/80	80/45	11	770	
	PNUDKABZ-100	Urethane	SUS									770	
	PNUAKABZ-100	Urethane										710	
	■ Monomer Cast Nylon												
	UWBKABZ-100	MC Nylon	B/B	200	204.0	29	12	144	115/80	80/45	11	900	
	UWBKABZ-100	MC Nylon	SUS									900	
	UWAKABZ-100	MC Nylon										850	
	UWBSKABZ-100	MC Nylon	B/B									850	
	UWBSDKABZ-100	MC Nylon	SUS			30	850						
	■ Steel Rim · Rubber Wheel <b>Wheel rim is not stainless steel.</b>												
	SKABZ-100	Rubber	B/B	130	132.6	35	12	144	115/80	80/45	11	890	
SRKABZ-100	Red Rubber	B/B	100	102.0	890								
CRKABZ-100	Heat-resistance	B/B	130	132.6	920								
■ Steel Rim · Urethane Rubber Wheel <b>Wheel rim is not stainless steel.</b>													
SUIKABZ-100	Urethane	B/B	180	183.6	32	12	144	115/80	80/45	11	960		
SUIEKABZ-100	Anti-Static	B/B									960		

● The stopper pedal for left foot is available (KABZ-100 → KABZL-100).

Bearing: No mark -- Spindle sleeve, B/B -- Steel bearing, SUS -- Stainless steel bearing

     Build-to-order manufacturing

The stopper of the KABZ Type bracket can lock the wheel to stop the castor.

● The materials of KABZ Type bracket are all stainless steel (SUS 304 / 18-8 stainless), except plate springs.

For plate springs, SK5 (carbon tool steel) is used for maintaining spring performance, and the surface is plated with nickel chrome.

# KABZ<sub>Type</sub>

Size: 130mm

Stainless Steel Rigid Bracket with Stopper



PKABZ-130

PNAKABZ-130

Size 	Model Number	Wheel	Bearing	Load Capacity		Tire Width R	Shaft Diameter D	Overall Height H1	Plate Size F1/F2	Mounting Hole Spacing P1/P2	Plate Hole d	Weight (g)	
				(daN)	(kgf)								
130	■ Nylon												
	PKABZ-130	Nylon		150	153.0	42	20	177	137/93	100/56	11	1,310	
	PBKABZ-130	Nylon	B/B	250	255.0							1,510	
	PBDKABZ-130	Nylon	SUS									1,510	
	■ Nylon Rim · Rubber Wheel												
	PNKABZ-130	Rubber	B/B	145	147.9	38	20	177	137/93	100/56	11	1,570	
	PNDKABZ-130	Rubber	SUS									1,570	
	PNAKABZ-130	Rubber										1,380	
	■ Nylon Rim · Urethane Rubber Wheel												
	PNUKABZ-130	Urethane	B/B	200	204.0	35	20	177	137/93	100/56	11	1,510	
	PNUDKABZ-130	Urethane	SUS									1,510	
	PNUAKABZ-130	Urethane										1,320	
	■ Monomer Cast Nylon												
	UWBKABZ-130	MC Nylon	B/B	300	306.0	36	20	177	137/93	100/56	11	1,790	
	UWBDKABZ-130	MC Nylon	SUS									1,790	
	UWAKABZ-130	MC Nylon										1,640	
	UWBSKABZ-130	MC Nylon	B/B									1,530	
	UWBSDKABZ-130	MC Nylon	SUS			1,530							
	■ Steel Rim · Rubber Wheel <b>Wheel rim is not stainless steel.</b>												
	SKABZ-130	Rubber	B/B	180	183.6	42	20	177	137/93	100/56	11	1,770	
	SRKABZ-130	Red Rubber	B/B	140	142.8							1,770	
CRKABZ-130	Heat-resistance	B/B	180	183.6	1,800								
■ Steel Rim · Urethane Rubber Wheel <b>Wheel rim is not stainless steel.</b>													
SUIKABZ-130	Urethane	B/B	250	255.0	35	20	177	137/93	100/56	11	1,900		
SUIEKABZ-130	Anti-Static	B/B									1,900		

Unit: mm

● The stopper pedal for left foot is available (KABZ-130 → KABZL-130).

Bearing: No mark -- Spindle sleeve, B/B -- Steel bearing, SUS -- Stainless steel bearing

Build-to-order manufacturing

The stopper of the KABZ Type bracket can lock the wheel to stop the caster.

● The materials of KABZ Type bracket are all stainless steel (SUS 304 / 18-8 stainless), except plate springs.

For plate springs, SK5 (carbon tool steel) is used for maintaining spring performance, and the surface is plated with nickel chrome.

# KABZ<sub>Type</sub>

Size: 150mm

Stainless Steel Rigid Bracket with Stopper



PKABZ-150



PNAKABZ-150

Stainless Steel Caster Series

Unit: mm

Size 	Model Number	Wheel	Bearing	Load Capacity		Tire Width R	Shaft Diameter D	Overall Height H1	Plate Size F1/F2	Mounting Hole Spacing P1/P2	Plate Hole d	Weight (g)	
				(daN)	(kgf)								
150	■ Nylon												
	PKABZ-150	Nylon		180	183.6	45	20	198	137/93	100/56	11	1,560	
	PBKABZ-150	Nylon	B/B	300	306.0							1,800	
	PBDKABZ-150	Nylon	SUS									1,800	
	■ Nylon Rim · Rubber Wheel												
	PNKABZ-150	Rubber	B/B	175	178.5	38	20	198	137/93	100/56	11	1,820	
	PNDKABZ-150	Rubber	SUS									1,820	
	PNAKABZ-150	Rubber										140	142.8
	■ Nylon Rim · Urethane Rubber Wheel												
	PNUKABZ-150	Urethane	B/B	250	255.0	38	20	198	137/93	100/56	11	1,780	
	PNUDKABZ-150	Urethane	SUS									1,780	
	PNUAKABZ-150	Urethane										150	153.0
	■ Monomer Cast Nylon												
	UWBKABZ-150	MC Nylon	B/B	350	357.0	40	20	198	137/93	100/56	11	2,240	
	UWBDKABZ-150	MC Nylon	SUS									2,240	
	UWAKABZ-150	MC Nylon										2,090	
	UWBSKABZ-150	MC Nylon	B/B									1,840	
	UWBSDKABZ-150	MC Nylon	SUS			30	1,840						
	■ Steel Rim · Rubber Wheel <b>Wheel rim is not stainless steel.</b>												
	SKABZ-150	Rubber	B/B	200	204.0	45	20	198	137/93	100/56	11	2,110	
SRKABZ-150	Red Rubber	B/B	160	163.2	2,110								
CRKABZ-150	Heat-resistance	B/B	200	204.0	2,150								
■ Steel Rim · Urethane Rubber Wheel <b>Wheel rim is not stainless steel.</b>													
SUIKABZ-150	Urethane	B/B	300	306.0	38	20	198	137/93	100/56	11	2,300		
SUIEKABZ-150	Anti-Static	B/B									2,300		

● The stopper pedal for left foot is available (KABZ-150 → KABZL-150).

Bearing: No mark -- Spindle sleeve, B/B -- Steel bearing, SUS -- Stainless steel bearing

     Build-to-order manufacturing

The stopper of the KABZ Type bracket can lock the wheel to stop the caster.

● The materials of KABZ Type bracket are all stainless steel (SUS 304 / 18-8 stainless), except plate springs.

For plate springs, SK5 (carbon tool steel) is used for maintaining spring performance, and the surface is plated with nickel chrome.

# KABZ<sub>Type</sub>

Size: 200mm

Stainless Steel Rigid Bracket with Stopper

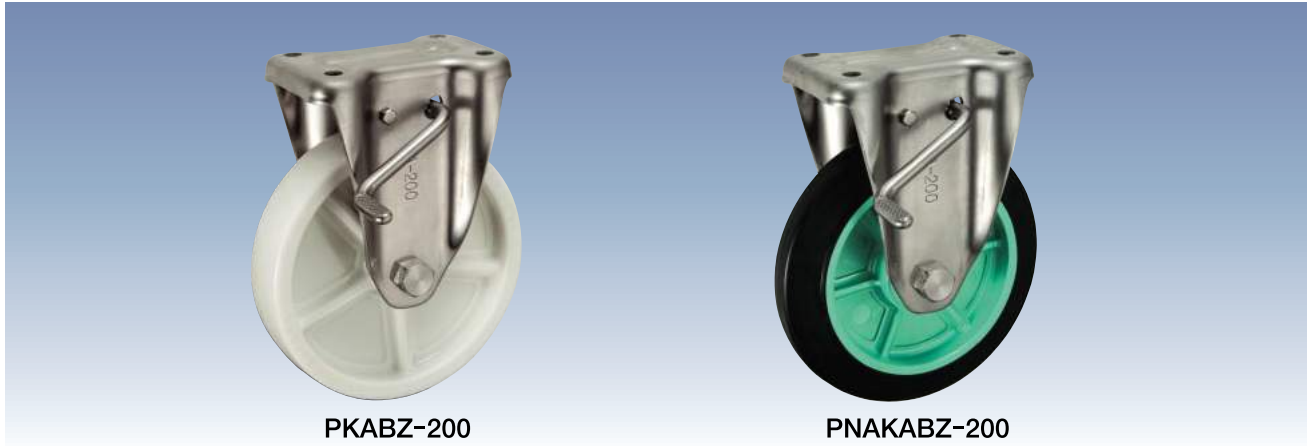

PKABZ-200

PNAKABZ-200

Size 	Model Number	Wheel	Bearing	Load Capacity		Tire Width R	Shaft Diameter D	Overall Height H1	Plate Size F1/F2	Mounting Hole Spacing P1/P2	Plate Hole d	Weight (g)	
				(daN)	(kgf)								
200	<b>■ Nylon</b>												
	PKABZ-200	Nylon		250	255.0	45	20	250	151/102	112/63	11	2,520	
	PBKABZ-200	Nylon	B/B	400	408.0							2,730	
	PBDKABZ-200	Nylon	SUS									2,730	
	<b>■ Nylon Rim · Rubber Wheel</b>												
	PNKABZ-200	Rubber	B/B	220	224.4	42	20	250	151/102	112/63	11	2,800	
	PNDKABZ-200	Rubber	SUS									2,800	
	PNAKABZ-200	Rubber										160	163.2
	<b>■ Nylon Rim · Urethane Rubber Wheel</b>												
	PNUKABZ-200	Urethane	B/B	350	357.0	42	20	250	151/102	112/63	11	2,670	
	PNUDKABZ-200	Urethane	SUS									2,670	
	PNUAKABZ-200	Urethane										250	255.0
	<b>■ Monomer Cast Nylon</b>												
	UWBKABZ-200	MC Nylon	B/B	500	510.0	42	20	250	151/102	112/63	11	3,680	
	UWBDKABZ-200	MC Nylon	SUS									3,680	
	UWAKABZ-200	MC Nylon										3,530	
	UWBSKABZ-200	MC Nylon	B/B			34						3,140	
	UWBSDKABZ-200	MC Nylon	SUS									3,140	
	<b>■ Steel Rim · Rubber Wheel</b> <i>Wheel rim is not stainless steel.</i>												
	SKABZ-200	Rubber	B/B	250	255.0	45	20	250	151/102	112/63	11	3,450	
	SRKABZ-200	Red Rubber	B/B	200	204.0							3,450	
	SHKABZ-200	High-Rebound	B/B	250	255.0							3,450	
CRKABZ-200	Heat-resistance	B/B	3,530										
<b>■ Steel Rim · Urethane Rubber Wheel</b> <i>Wheel rim is not stainless steel.</i>													
SUIKABZ-200	Urethane	B/B	400	408.0	42	20	250	151/102	112/63	11	3,620		
SUIEKABZ-200	Anti-Static	B/B									3,620		

Unit: mm

● The stopper pedal for left foot is available (KABZ-200 → KABZL-200).

Bearing: No mark -- Spindle sleeve, B/B -- Steel bearing, SUS -- Stainless steel bearing

     Build-to-order manufacturing

The stopper of the KABZ Type bracket can lock the wheel to stop the caster.

● The materials of KABZ Type bracket are all stainless steel (SUS 304 / 18-8 stainless), except plate springs.

For plate springs, SK5 (carbon tool steel) is used for maintaining spring performance, and the surface is plated with nickel chrome.

# KABZ<sub>Type</sub>



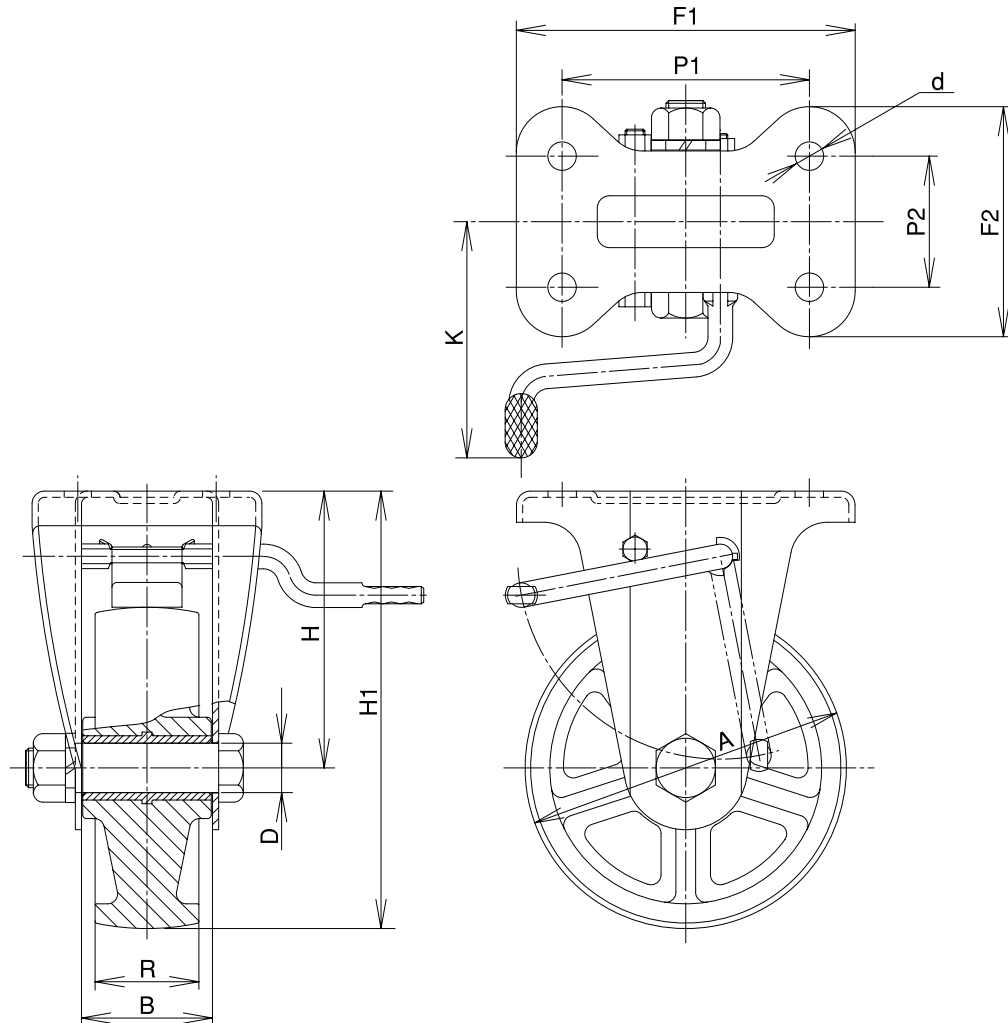

*Stainless Steel Rigid Bracket with Stopper*



Stainless Steel Caster Series



**[Bracket Dimensions]**

Unit: mm

Size 	Load Capacity 		Bracket Height H 	Bracket Width B 	Weight (g) 
	(daN)	(kgf)			
75	150	153.0	63	40	270
100	200	204.0	94	43	530
130	300	306.0	112	53	990
150	350	357.0	123	56	1,150
200	500	510.0	150	56	1,780

**[Pedal Dimensions]**

Unit: mm

Size 	Pedal Rod K 
75	72
100	100
130	112
150	112
200	112

## Notice

The materials of KABZ Type bracket are all stainless steel, but the following wheels are not stainless steel. In addition, stainless steel bearings cannot be set. Please be careful when selecting a caster.

**Steel Rim • Rubber Wheel (S, SR, SH, CR Type)**  
**Steel Rim • Urethane Wheel (SUI, SUIE Type)**

\* The shaft set is included in the bracket.