

# KBZ<sub>Type</sub>

Size: 75mm

Medium Weight Rigid Bracket with Stopper











SKBZ-75

SUIKBZ-75

SKBZL-75

Unit: mm

Size 	Model Number	Wheel	Bearing	Load Capacity 		Tire Width R 	Shaft Diameter D 	Overall Height H1 	Plate Size F1/F2 	Mounting Hole Spacing P1/P2 	Plate Hole d 	Weight (g) 
				(daN)	(kgf)							
75	■ Steel Rim · Rubber Wheel											
	SKBZ-75	Rubber	B/B	80	81.6	32	10	101	91/68	63/40	9.5	480
	SRKBZ-75	Red Rubber	B/B	60	61.2							480
	CRKBZ-75	Heat-resistance	B/B	80	81.6							500
	■ Steel Rim · Urethane Rubber Wheel											
	SUIKBZ-75	Urethane	B/B	120	122.4	32	10	101	91/68	63/40	9.5	560
	SUIEKBZ-75	Anti-Static	B/B									560
	■ Nylon Rim · Rubber Wheel											
	PNKBZ-75	Rubber	B/B	70	71.4	32	10	101	91/68	63/40	9.5	460
	PNDKBZ-75	Rubber	SUS									460
	PNAKBZ-75	Rubber										420
	■ Nylon Rim · Urethane Rubber Wheel											
	PNUKBZ-75	Urethane	B/B	100	102.0	32	10	101	91/68	63/40	9.5	450
	PNUDKBZ-75	Urethane	SUS									450
	PNUAKBZ-75	Urethane		70	71.4							400
	■ Nylon											
	PKBZ-75	Nylon		100	102.0	32	10	101	91/68	63/40	9.5	370
	PBKBZ-75	Nylon	B/B	120	122.4							430
	PBDBKZ-75	Nylon	SUS									430
	■ Monomer Cast Nylon											
UWBKBZ-75	MC Nylon	B/B	120	122.4	24	10	101	91/68	63/40	9.5	470	
UWBDBKZ-75	MC Nylon	SUS									470	
UWAKBZ-75	MC Nylon										430	
UWBSKBZ-75	MC Nylon	B/B			26						450	
UWBSDKBZ-75	MC Nylon	SUS									450	

● The stopper pedal for left foot is available (KBZ-75 → KBZL-75).

Bearing: No mark -- Spindle sleeve, B/B -- Steel bearing, SUS -- Stainless steel bearing

     Build-to-order manufacturing

The stopper of the KBZ Type bracket can lock the wheel to stop the caster.

# KBZ Type

Size: 100mm

Medium Weight Rigid Bracket with Stopper



SKBZ-100

SUIKBZ-100

SKBZL-100

Medium Weight Caster Series

Unit: mm

Size 	Model Number	Wheel	Bearing	Load Capacity		Tire Width R	Shaft Diameter D	Overall Height H1	Plate Size F1/F2	Mounting Hole Spacing P1/P2	Plate Hole d	Weight (g)
				 (daN)	(kgf)							
100	<b>■ Steel Rim · Rubber Wheel</b>											
	SKBZ-100	Rubber	B/B	130	132.6	35	12	144	115/80	80/45	11	920
	SRKBZ-100	Red Rubber	B/B	100	102.0							920
	CRKBZ-100	Heat-resistance	B/B	130	132.6							950
	<b>■ Steel Rim · Urethane Rubber Wheel</b>											
	SUIKBZ-100	Urethane	B/B	180	183.6	32	12	144	115/80	80/45	11	990
	SUIEKBZ-100	Anti-Static	B/B									990
	<b>■ Nylon Rim · Rubber Wheel</b>											
	PNKBZ-100	Rubber	B/B	100	102.0	32	12	144	115/80	80/45	11	820
	PNDKBZ-100	Rubber	SUS									820
	PNAKBZ-100	Rubber										760
	<b>■ Nylon Rim · Urethane Rubber Wheel</b>											
	PNUKBZ-100	Urethane	B/B	150	153.0	32	12	144	115/80	80/45	11	800
	PNUDKBZ-100	Urethane	SUS									800
	PNUAKBZ-100	Urethane		100	102.0							740
	<b>■ Nylon</b>											
	PKBZ-100	Nylon		120	122.4	35	12	144	115/80	80/45	11	720
	PBKBZ-100	Nylon	B/B	180	183.6							780
	PBDKBZ-100	Nylon	SUS									780
	<b>■ Monomer Cast Nylon</b>											
	UWBKBZ-100	MC Nylon	B/B	180	183.6	29	12	144	115/80	80/45	11	930
UWBDBZ-100	MC Nylon	SUS	930									
UWAKBZ-100	MC Nylon		880									
UWBSKBZ-100	MC Nylon	B/B	30			880						
UWBSDKBZ-100	MC Nylon	SUS				880						

● The stopper pedal for left foot is available (KBZ-100 → KBZL-100).

Bearing: No mark -- Spindle sleeve, B/B -- Steel bearing, SUS -- Stainless steel bearing

Build-to-order manufacturing

The stopper of the KBZ Type bracket can lock the wheel to stop the caster.

# KBZ<sub>Type</sub>

Size: 130mm

Medium Weight Rigid Bracket with Stopper



SKBZ-130

SUIKBZ-130

SKBZL-130

Unit: mm

Size 	Model Number	Wheel	Bearing	Load Capacity		Tire Width R	Shaft Diameter D	Overall Height H1	Plate Size F1/F2	Mounting Hole Spacing P1/P2 (P2')	Plate Hole d	Weight (g)	
				(daN)	(kgf)								
130	■ Steel Rim · Rubber Wheel												
	SKBZ-130	Rubber	B/B	180	183.6	42	20	177	137/93	※100/56 (50)	11	1,750	
	SRKBZ-130	Red Rubber	B/B	140	142.8							1,750	
	CRKBZ-130	Heat-resistance	B/B	180	183.6							1,780	
	■ Steel Rim · Urethane Rubber Wheel												
	SUIKBZ-130	Urethane	B/B	250	255.0	35	20	177	137/93	※100/56 (50)	11	1,880	
	SUIKBZ-130	Anti-Static	B/B									1,880	
	■ Nylon Rim · Rubber Wheel												
	PNKBZ-130	Rubber	B/B	145	147.9	38	20	177	137/93	※100/56 (50)	11	1,550	
	PNDKBZ-130	Rubber	SUS									1,550	
	PNAKBZ-130	Rubber										120	122.4
	■ Nylon Rim · Urethane Rubber Wheel												
	PNUKBZ-130	Urethane	B/B	200	204.0	35	20	177	137/93	※100/56 (50)	11	1,490	
	PNUDKBZ-130	Urethane	SUS									1,490	
	PNUAKBZ-130	Urethane										120	122.4
	■ Nylon												
	PKBZ-130	Nylon		250	255.0	42	20	177	137/93	※100/56 (50)	11	1,290	
	PBKBZ-130	Nylon	B/B									1,490	
	PBDKBZ-130	Nylon	SUS									1,490	
	■ Monomer Cast Nylon												
UWBKBZ-130	MC Nylon	B/B	250	255.0	36	20	177	137/93	※100/56 (50)	11	1,770		
UWBDBZ-130	MC Nylon	SUS									1,770		
UWAKBZ-130	MC Nylon										1,620		
UWBSKBZ-130	MC Nylon	B/B									1,510		
UWBSDKBZ-130	MC Nylon	SUS			30						1,510		

● The stopper pedal for left foot is available (KBZ-130 → KBZL-130).

※Oval-shaped screw holes

Bearing: No mark -- Spindle sleeve, B/B -- Steel bearing, SUS -- Stainless steel bearing

     Build-to-order manufacturing

The stopper of the KBZ Type bracket can lock the wheel to stop the caster.

# KBZ Type

Size: 150mm

Medium Weight Rigid Bracket with Stopper



SKBZ-150

SUIKBZ-150

SKBZL-150

Medium Weight Caster Series

Unit: mm

Size 	Model Number	Wheel	Bearing	Load Capacity		Tire Width R	Shaft Diameter D	Overall Height H1	Plate Size F1/F2	Mounting Hole Spacing P1/P2 (P2')	Plate Hole d	Weight (g)	
				(daN)	(kgf)								
150	■ Steel Rim · Rubber Wheel												
	SKBZ-150	Rubber	B/B	200	204.0	45	20	198	137/93	※100/56 (50)	11	2,140	
	SRKBZ-150	Red Rubber	B/B	160	163.2							2,140	
	CRKBZ-150	Heat-resistance	B/B	200	204.0							2,180	
	■ Steel Rim · Urethane Rubber Wheel												
	SUIKBZ-150	Urethane	B/B	300	306.0	38	20	198	137/93	※100/56 (50)	11	2,330	
	SUIEKBZ-150	Anti-Static	B/B									2,330	
	■ Nylon Rim · Rubber Wheel												
	PNKBZ-150	Rubber	B/B	175	178.5	38	20	198	137/93	※100/56 (50)	11	1,850	
	PNDKBZ-150	Rubber	SUS									1,850	
	PNAKBZ-150	Rubber										140	142.8
	■ Nylon Rim · Urethane Rubber Wheel												
	PNUKBZ-150	Urethane	B/B	250	255.0	38	20	198	137/93	※100/56 (50)	11	1,810	
	PNUDKBZ-150	Urethane	SUS									1,810	
	PNUAKBZ-150	Urethane		150	153.0							1,620	
	■ Nylon												
	PKBZ-150	Nylon		180	183.6	45	20	198	137/93	※100/56 (50)	11	1,590	
	PBKBZ-150	Nylon	B/B	300	306.0							1,830	
	PBDKBZ-150	Nylon	SUS									1,830	
	■ Monomer Cast Nylon												
UWBKBZ-150	MC Nylon	B/B	300	306.0	40	20	198	137/93	※100/56 (50)	11	2,270		
UWBDBZ-150	MC Nylon	SUS									2,270		
UWAKBZ-150	MC Nylon										2,120		
UWBSKBZ-150	MC Nylon	B/B									1,870		
UWBSDKBZ-150	MC Nylon	SUS			30						1,870		

● The stopper pedal for left foot is available (KBZ-150 → KBZL-150).

※ Oval-shaped screw holes

Bearing: No mark -- Spindle sleeve, B/B -- Steel bearing, SUS -- Stainless steel bearing

Build-to-order manufacturing

The stopper of the KBZ Type bracket can lock the wheel to stop the caster.

# KBZ<sub>Type</sub>

Size: 200mm

Medium Weight Rigid Bracket with Stopper



SKBZ-200

SUIKBZ-200

SKBZL-200

Unit: mm

Size 	Model Number	Wheel	Bearing	Load Capacity		Tire Width R	Shaft Diameter D	Overall Height H1	Plate Size F1/F2	Mounting Hole Spacing P1/P2	Plate Hole d	Weight (g)	
				(daN)	(kgf)								
200	■ Steel Rim · Rubber Wheel												
	SKBZ-200	Rubber	B/B	250	255.0	45	20	250	151/102	112/63	11	3,600	
	SRKBZ-200	Red Rubber	B/B	200	204.0							3,600	
	SHKBZ-200	High-Rebound	B/B	250	255.0							3,600	
	CRKBZ-200	Heat-resistance	B/B									3,680	
	■ Steel Rim · Urethane Rubber Wheel												
	SUIKBZ-200	Urethane	B/B	400	408.0	42	20	250	151/102	112/63	11	3,770	
	SUIEBZ-200	Anti-Static	B/B									3,770	
	■ Nylon Rim · Rubber Wheel												
	PNKBZ-200	Rubber	B/B	220	224.4	42	20	250	151/102	112/63	11	2,950	
	PNDKBZ-200	Rubber	SUS									2,950	
	PNAKBZ-200	Rubber										160	163.2
	■ Nylon Rim · Urethane Rubber Wheel												
	PNUKBZ-200	Urethane	B/B	350	357.0	42	20	250	151/102	112/63	11	2,820	
	PNUDKBZ-200	Urethane	SUS									2,820	
	PNUAKBZ-200	Urethane										250	255.0
	■ Nylon												
	PKBZ-200	Nylon		250	255.0	45	20	250	151/102	112/63	11	2,670	
	PBKBZ-200	Nylon	B/B	400	408.0							2,880	
	PBDKBZ-200	Nylon	SUS									2,880	
	■ Monomer Cast Nylon												
	UWBKBZ-200	MC Nylon	B/B	420	428.4	42	20	250	151/102	112/63	11	3,830	
	UWBDBZ-200	MC Nylon	SUS									3,830	
UWAKBZ-200	MC Nylon		3,680										
UWBSKBZ-200	MC Nylon	B/B	3,290										
UWBSDKBZ-200	MC Nylon	SUS	34			3,290							

● The stopper pedal for left foot is available (KBZ-200 → KBZL-200).

Bearing: No mark -- Spindle sleeve, B/B -- Steel bearing, SUS -- Stainless steel bearing

     Build-to-order manufacturing

The stopper of the KBZ Type bracket can lock the wheel to stop the caster.

# KBZ<sub>Type</sub>

Medium Weight Rigid Bracket with Stopper

Medium Weight Caster Series

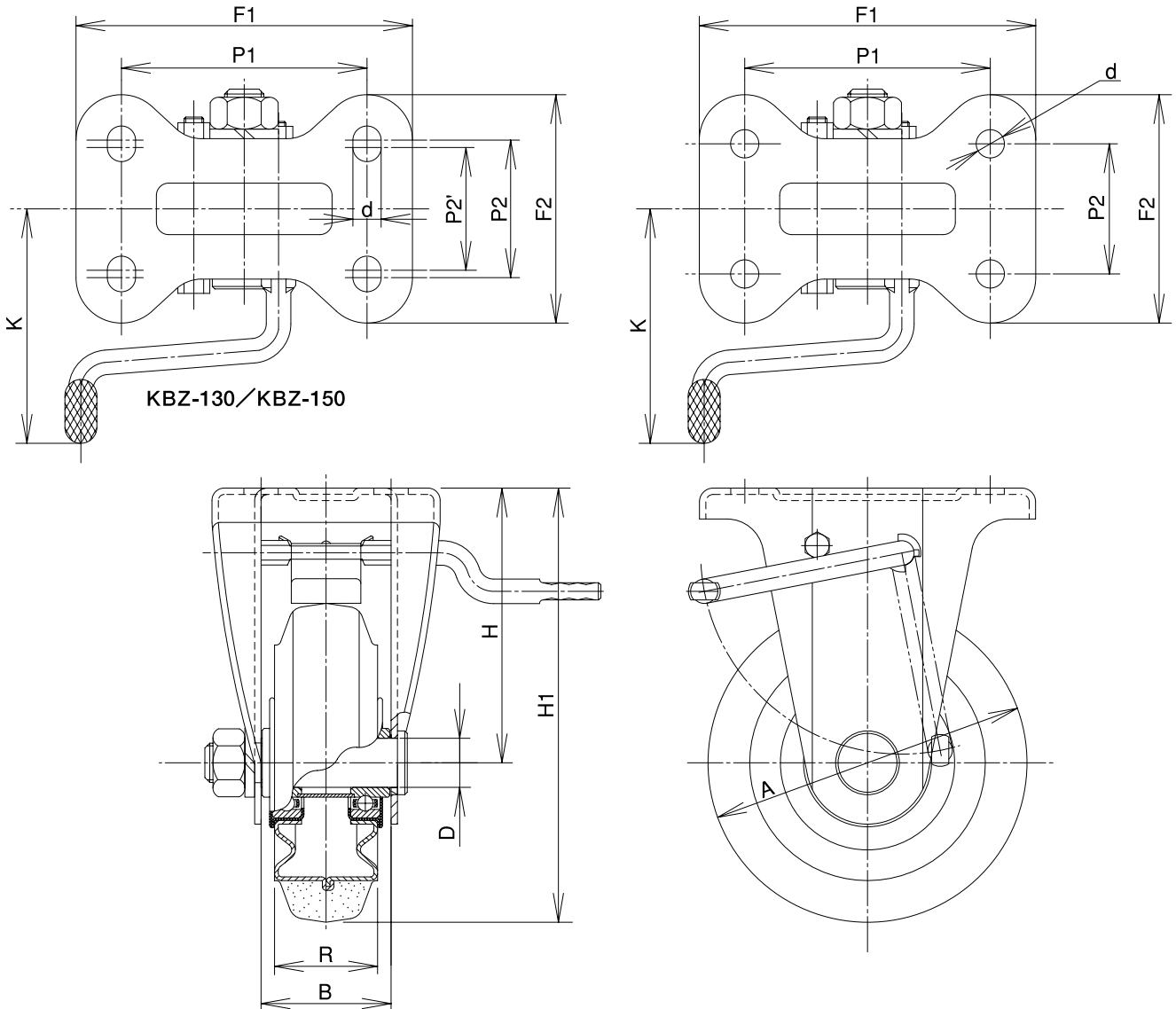

KBZ-130/KBZ-150

**【Bracket Dimensions】**

Unit: mm

Size 	Load Capacity 		Bracket Height H 	Bracket Width B 	Weight (g) 
	(daN)	(kgf)			
75	120	122.4	63	40	280
100	180	183.6	94	43	560
130	250	255.0	112	53	970
150	300	306.0	123	56	1,180
200	420	428.4	150	56	1,930

**【Pedal Dimensions】**

Unit: mm

Size 	Pedal Rod K 
75	72
100	100
130	112
150	112
200	112

\* The shaft set is included in the bracket.