

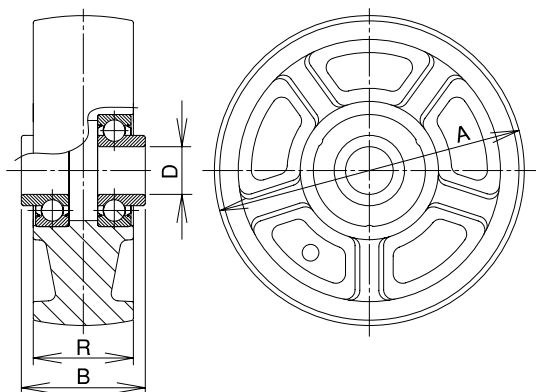

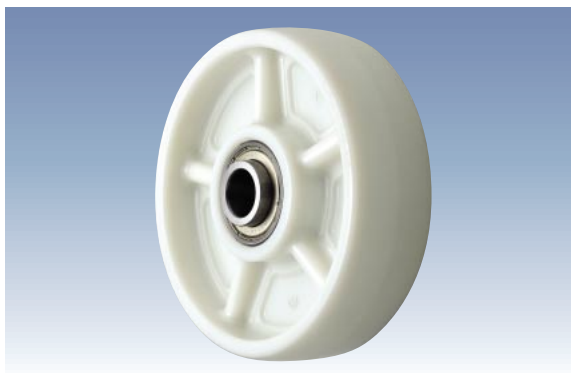



# PB/PBD Type

Wheel

## PB Type Nylon Wheel



Unit: mm



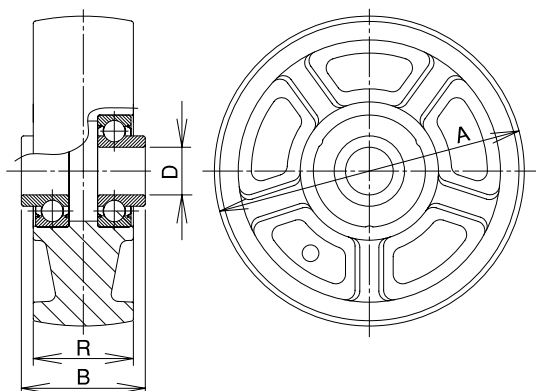
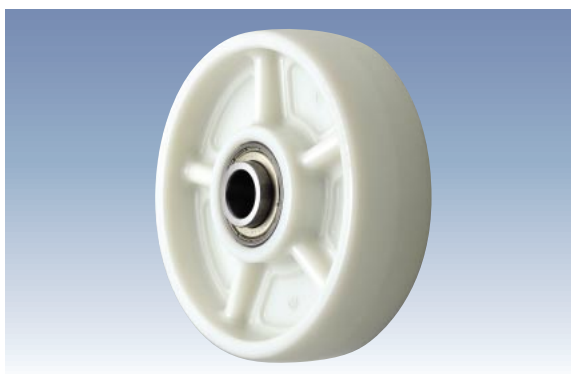

Size 	Model Number	Load Capacity		Boss Width B 	Tire Width R 	Shaft Diameter D 	Steel Radial Bearing	Weight (g) 	Compatible Caster Bracket
		(daN)	(kgf)						
75	PB-75	120	122.4	39	32	10	6200ZZY	150	J, JA K, KA JB, JAB KBZ, KABZ
100	PB-100	180	183.6	42	35	12	6201ZZY	220	
130	PB-130	250	255.0	52	42	20	6204ZZY	520	
150	PB-150	300	306.0	55	45	20	6204ZZY	650	
200	PB-200	400	408.0	55	45	20	6204ZZY	950	

Wheel: Nylon6

## PBD Type Nylon Wheel (Including Stainless Steel Bearings)



Unit: mm

Size 	Model Number	Load Capacity		Boss Width B 	Tire Width R 	Shaft Diameter D 	Stainless Steel Radial Bearing	Weight (g) 	Compatible Caster Bracket
		(daN)	(kgf)						
75	PBD-75	120	122.4	39	32	10	SUS 6200ZZ	150	J, JA K, KA JB, JAB KBZ, KABZ
100	PBD-100	180	183.6	42	35	12	SUS 6201ZZY	220	
130	PBD-130	250	255.0	52	42	20	SUS 6204ZZY	520	
150	PBD-150	300	306.0	55	45	20	SUS 6204ZZY	650	
200	PBD-200	400	408.0	55	45	20	SUS 6204ZZY	950	

Wheel: Nylon6