

# RGN/RG Type

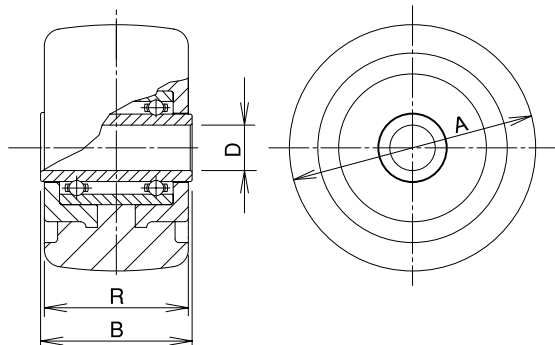



Wheel

## RGN Type Heavy Duty Reinforced Nylon Wheel



RGN-100

Unit: mm

Size 	Model Number	Load Capacity		Boss Width B 	Tire Width R 	Shaft Diameter D 	Steel Ball Bearing	Weight (g) 	Compatible Caster Bracket
		(daN)	(kgf)						
50	RGN-50	200	204.0	31	28	10	1022SBW	110	JM, KH
65	RGN-65	300	306.0	40	38	12	1230SBW	220	
75	RGN-75	400	408.0	40	38	12	1230SBW	270	
100	RGN-100	500	510.0	56	45	12	1241SBW	500	JM, KH, JMB



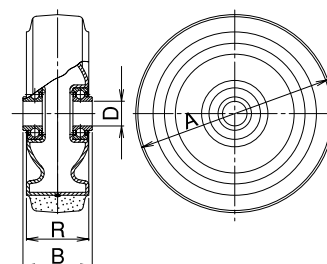
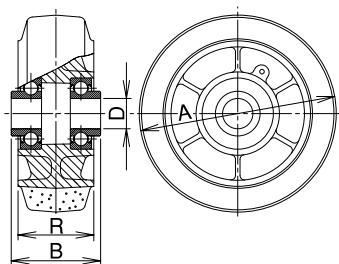

Wheel: Nylon 6 and fiberglass-mixed materials

## RG Type Heavy Duty Polybutadiene Rubber Wheel



RG-200

Unit: mm

Size 	Model Number	Load Capacity		Boss Width B 	Tire Width R 	Shaft Diameter D 	Steel Radial Bearing	Weight (g) 	Compatible Caster Bracket
		(daN)	(kgf)						
100	RG-100	200	204.0	56	50	12	6201ZZY	530	JM, KH, JMB
130	RG-130	240	244.8	59	50	20	6204ZZY	910	JM, JH, KH, JMB
150	RG-150	300	306.0	59	50	20	6204ZZY	1,130	JM, JH, JHW, KH, KHW, JMB, JHB
200	RG-200	410	418.2	70	63	25	6205ZZY	2,560	JM, JH, JHW, KH, KHW, JMB

Wheel Rim: RG-100/130/150  
RG-200

Aluminum alloy for die casting (ADC-12)  
Steel