

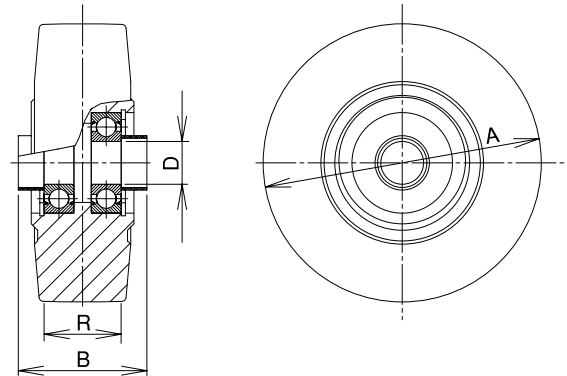

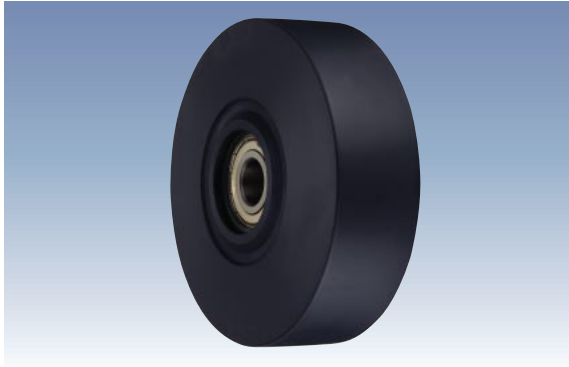



UWBD_{Type}

Wheel

UWBD Type MC Nylon Wheel (Including Stainless Steel Bearings)



Unit: mm

Size 	Model Number	Load Capacity		Boss Width B 	Tire Width R 	Shaft Diameter D 	Stainless Steel Radial Bearing	Weight (g) 	Compatible Caster Bracket
		(daN)	(kgf)						
75	UWBD-75	360	367.2	39	24	10	SUS 6200ZZ	190	J, K, JB, KBZ JA, KA, JAB, KABZ
100	UWBD-100	520	530.4	42	29	12	SUS 6201ZZ	370	
130	UWBD-130	890	907.8	52	36	20	SUS 6204ZZ	800	
150	UWBD-150	1,040	1,060.8	55	40	20	SUS 6204ZZ	1,090	
200	UWBD-200	1,400	1,428.0	55	42	20	SUS 6204ZZ	1,900	

Monomer Cast Nylon Wheel (with Stainless Steel Collar)

Please be careful about the load capacity of the mounting bracket.